

A large, industrial Grundfos pump is the central focus of the image. It is a heavy-duty, grey-painted metal unit with a prominent circular flange on the front. The pump is situated in a complex industrial environment with various pipes, metal structures, and other machinery visible in the background. The lighting is dramatic, highlighting the textures of the metal and the intricate details of the pump's design. The overall scene conveys a sense of industrial strength and reliability.

GRUNDFOS DISTRICT HEATING

Intelligent, efficient and reliable

be
think
innovate

GRUNDFOS 

LOWER TEMPERATURES TO EFFECTIVELY USE RENEWABLE ENERGY SOURCES AND REDUCE HEAT LOSSES

District heating provides a lot of opportunities to effectively lower CO₂ emissions while increasing consumer comfort.

Considered the most effective way of distributing heat, there is strong political support around the world for a wide implementation of district heating, and to optimise existing methods. This will result in a significantly lower carbon footprint and cheaper energy for consumers, who do not have to give much thought of the installations in their house or building.

The benefits from recent advances in low temperature district heating enable effective utilisation of:

- Sustainable and renewable energy from wind, geothermal, solar thermal, etc.
- Surplus heat, for example from factories in a local community, that would otherwise be lost

Lowering temperatures is furthermore a huge benefit for many existing district heating networks, as this significantly reduces

heat losses and improves the overall system efficiency.

In most cases, no or limited investment is required; temperatures can easily be lowered with no negative consequences, due to original over-sizing of installations, energy renovation of buildings, etc.

Grundfos can help optimise your district heating to run with lower temperatures:

- Reliable and highly efficient pumps for any application on the production, distribution and consumption side in the district heating network
- Solutions that improve the efficiency of your system; e.g. temperature zoning, pressure boosting and pressure optimisation
- Services to ensure optimal operation and performance of your pumps in the system; e.g. commissioning, energy checks, pump audits and service contracts
- Consultancy on how to design the distribution system and utilise the intelligence built into our products and systems, helping you save money from the very first day



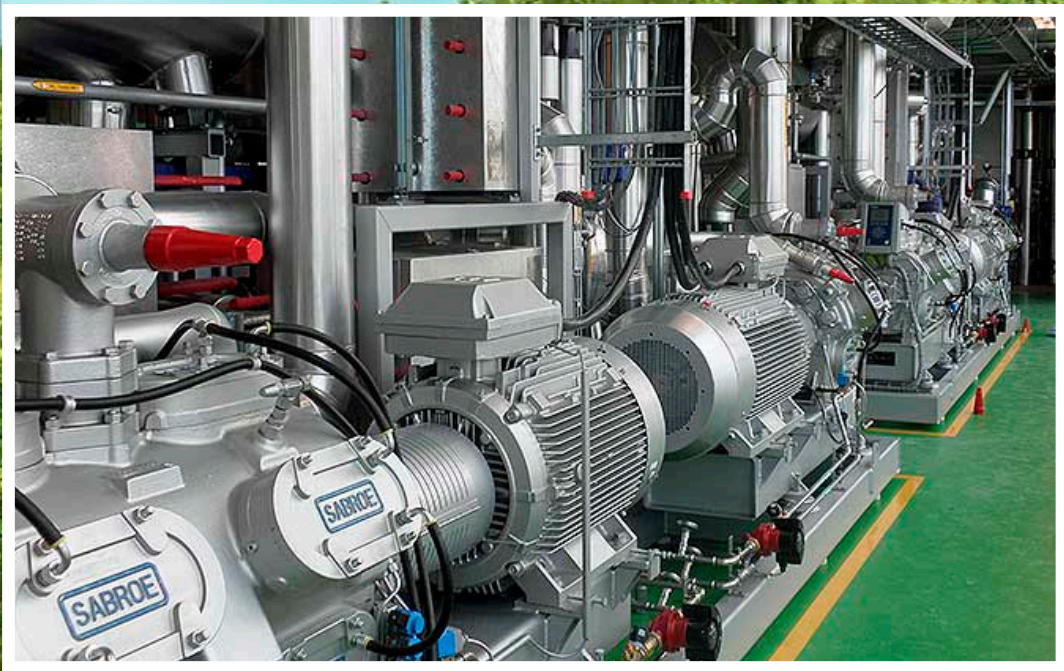

DISTRICT HEATING OVERVIEW



CHP POWER PLANT

MAIN PUMPS

6-7

FLOW FILTER PUMPS

9

WATER TREATMENT PUMPS

16

BOILER HOUSE

BOILER SHUNT PUMPS

8

LULL HEAT PUMPS

10

FLUE GAS ECONOMISER

11



DISTRIBUTION

13 **BOOSTER PUMPS**

13 **TEMPERATURE ZONING**

CONSUMER CONNECTIONS

14-15 **DIRECT CONNECTION**

14-15 **PLATE HEAT EXCHANGE**

14-15 **MIXING LOOPS**

SUB-STATION

12 **PRESSURE HOLDING SYSTEM**

13 **DISTRIBUTION PUMPS**

MAIN PUMPS

THE HEART OF YOUR HEATING SYSTEM

Main pumps are the beating hearts of any district heating system, pumping hot water from the power plant or boiler house to the substations. As the water needs to be pushed through miles and miles of piping before reaching its destination, strength and reliability are everything.

Maximum power, minimal maintenance





Our main pumps are built to perform and built to last. Decades of experience and dedication to craftsmanship ensures a solution that offers maximum power with an absolute minimum of maintenance. To ensure the most energy efficient solution, we recommend the use of speed-regulated pumps that adjust to constantly changing heating demands.

Acceptance Grade testing to the highest standards

Because even a marginal deviation has a huge impact on the energy consumption, Grundfos tests all our main pumps to ISO909906:2012 Acceptance Grade 3B as standard. All pumps can be tested on request to Grade 2, and up to Grade 1U without negative tolerances, ensuring considerable savings on energy consumption.

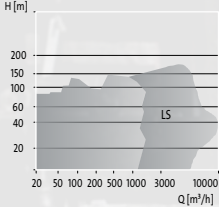
All products are:

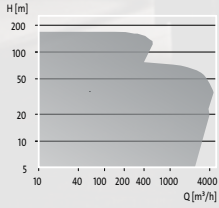
- Highly efficient and reliable
- Pressure tested and QH verified
- EN12756 certified
- Available in PN 10, 16, 25

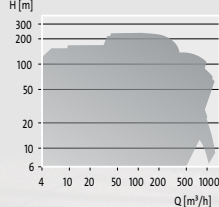
PUMP TYPE	OPERATING RANGE	FEATURES AND BENEFITS
 <p>HS & LS split-case pumps</p>		<ul style="list-style-type: none"> » In-line pump installation » Double volute casing for increased bearing lifetime » Removable bearing housing for easy service and maintenance
 <p>TP in-line pump Series 300</p>		<ul style="list-style-type: none"> » In-line pump installation » Small footprint » Simple installation (plug and pump)
 <p>NK/NKG end-suction pump</p>		<ul style="list-style-type: none"> » Easy to service » Easy replaceable – dimensions according to EN and ISO standards » Bearing lifetime up to 100,000 hours



Grundfos CUE variable speed drive

Grundfos CUE represents one of the most comprehensive and versatile ranges of frequency converters currently on the market. Preprogrammed for Grundfos pump families, CUE requires a minimum of configuration to ensure the automatic control of pump speed and the energy savings that follow. Quick set-up, easy commissioning, and optimal performance come as standard.



BOILER SHUNT PUMPS

KEEP SYSTEM PERFORMANCE HIGH FOR DECADES

Boiler shunt pumps play an important role in maintaining the performance of the system. By recirculating a certain amount of hot water from the flow pipe into the return pipe or directly into the boiler, the boiler shunt pump ensures that the temperature difference is never above acceptable levels. This is achieved by coupling an external temperature sensor to the controller for the boiler shunt pump. The result is reduced tensions in the boiler and the elimination of condensation, leading to a significantly prolonged system lifetime.

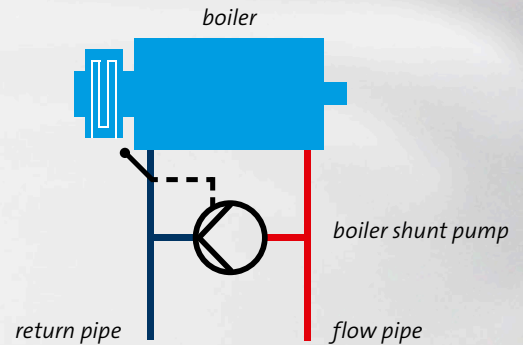

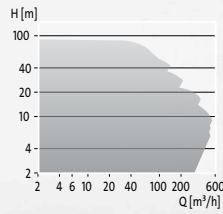
PUMP TYPE	OPERATING RANGE	FEATURES AND BENEFITS
 <p>TPE in-line pump</p>		<ul style="list-style-type: none"> » Low energy consumption » Intelligent control » Adaptation to existing operating conditions



Grundfos TPE

Adaptable, efficient and intelligent, the TPE in-line pumps are built to match any district heating need. All components are tailor-made and optimised for energy efficiency, resulting in energy savings of up to 50% compared to conventional pumps. The TP comes equipped with the highly efficient IE5 Grundfos Blueflux® motor and features an integrated frequency converter to ensure maximum efficiency at all times.



WATER QUALITY FIRST

In a district heating system, water quality is paramount. To ensure that the quality lives up to the given standards, it is necessary to continuously filter the water. This is done by means of flow filter pumps that recirculate approximately 10% of the total typical flow across a strainer, removing all impurities.

By choosing an intelligent Grundfos solution such as the TPE pump in combination with a differential pressure sensor, you can measure pressure loss across the strainer and thereby continuously secure the design flow.

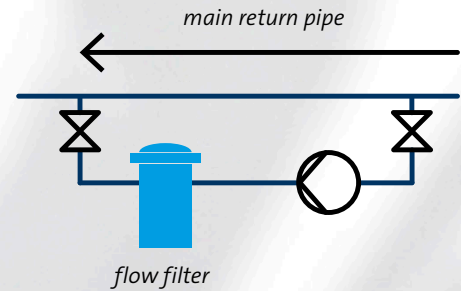
The Grundfos pumps below are all highly efficient (IE5 motors), easy to install, EN12756 certified and with built-in frequency control.

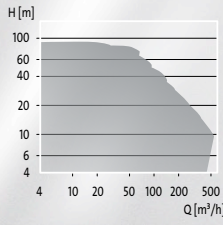

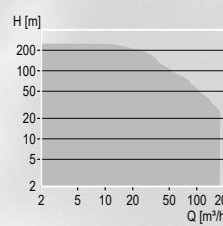
PUMP TYPE	OPERATING RANGE	FEATURES AND BENEFITS
 <p>NBE end-suction pump</p>		<ul style="list-style-type: none"> » Compact design » Easy replaceable – dimensions according to EN and ISO standards
 <p>CRE pump</p>		<ul style="list-style-type: none"> » High pressure pumps » Small footprint » In-line installation » Multi-stage pump



Grundfos CRE

By choosing the CRE pump, you will not only be rewarded with intelligent control and superior energy efficiency. The built-in control makes it possible to enable application-related functions to optimise system performance. The CRE pump comes with the highly efficient IE5 Grundfos Blueflux motors and functionalities.



LULL HEAT PUMPS

KEEP IT FLOWING

Even when a boiler is on standby, the flow through the boiler system must continue. This way, the system will be able to resume operation promptly and easily when needed without having to reheat the water first. By utilising a small temperature-regulated lull-heating pump, you ensure a quick start-up and optimal protection of your boiler.

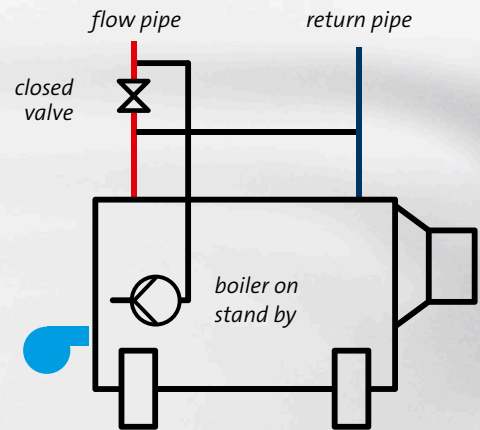
At Grundfos, we can provide you with a full range of lull heat pumps that will keep the water flowing effortlessly for years and years.



PUMP TYPE	OPERATING RANGE	FEATURES AND BENEFITS
 <p>MAGNA3 circulator pump</p>		<ul style="list-style-type: none"> » Low energy consumption » Temperature control » Operating log » No maintenance » Plug and pump
 <p>NBE end-suction pump</p>		<ul style="list-style-type: none"> » Compact design » Easy replaceable – dimensions according to EN and ISO standards » Intelligent control, incl. temperature control



Grundfos NBE end-suction pump



The NBE is an extremely reliable end-suction pump designed for the most demanding environments. Grundfos quality inside and out, it features our high efficiency e-motors that are all IE5 certified. Thoroughly tested before delivery, the NBE guarantees high performance and low cost of ownership.

FLUE GAS ECONOMISER

DON'T WASTE ENERGY

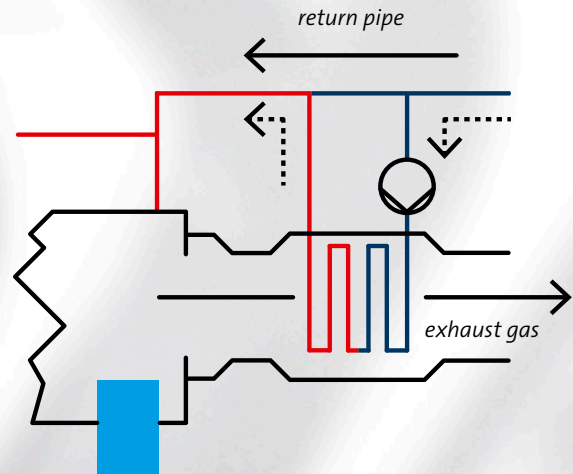
The overall efficiency of a boiler is heavily influenced by the temperature level of the boiler flue gas. The lower the temperature, the higher the efficiency. By installing an economiser between boiler and chimney or building it into the boiler exhaust, the flue gas can be cooled and the absorbed energy put to good use. This will reduce your fuel costs by up to 15% compared to a traditional operation without an economiser.

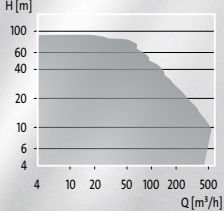

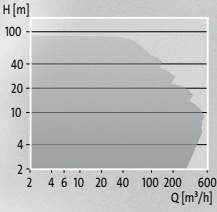
PUMP TYPE	OPERATING RANGE	FEATURES AND BENEFITS
 <p>NBE end-suction pump</p>		<ul style="list-style-type: none"> » Compact design » Easy replaceable – dimensions according to EN and ISO standards » Intelligent control, incl. temperature control
 <p>TPE in-line pump</p>		<ul style="list-style-type: none"> » Low energy consumption » Intelligent control » Adaptation to existing operating conditions



Grundfos MGE motors

All Grundfos E-pumps feature the groundbreaking IES-certified MGE motor. This offers much more control than a standard VFD and can be set up for almost any operation. In addition, it is engineered for increased performance and durability.

MGE motors offer automatic motor efficiency optimisation, no motor derating, cooling of frequency converter by motor fan, and low acoustic noise from motor.



PRESSURE HOLDING SYSTEMS

HANDLING THE PRESSURE

No two district heating systems are the same and even throughout a single system, demands vary constantly. In order to secure and maintain the right pressure in all parts of the system at all times, a pressure holding system is necessary.

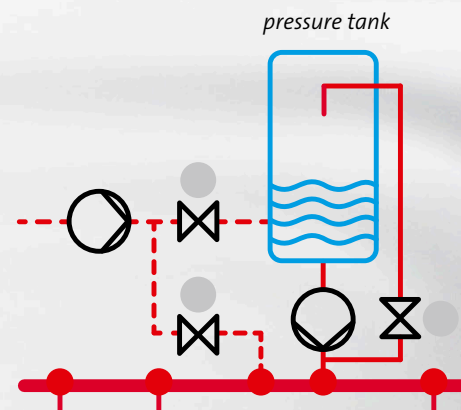
With a Grundfos pressure holding system, you are ready to take on any challenge. We make sure the system maintains static pressure, so your end users in tall buildings are guaranteed sufficient amounts of water with sufficient pressure. Furthermore, the risk of boiling points in the network is eliminated.

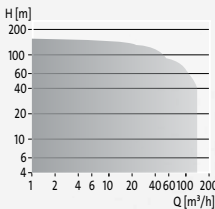

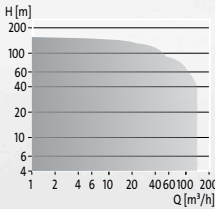
PUMP TYPE	OPERATING RANGE	FEATURES AND BENEFITS
 <p>Hydro MPC booster system</p>		<ul style="list-style-type: none"> » 2-6 pumps in cascade » Easy installation and start-up » Energy and application optimised control » Data communication » Perfect constant pressure
 <p>Hydro Multi-E booster system</p>		<ul style="list-style-type: none"> » Multi-master function » Pipe-filling function » Pre-defined setpoint » External set point influence » Limit-exceeded function



Grundfos CR Booster System



The Grundfos CR Booster ensures that the flow and pressure of your system adapts to current demands, reducing your energy costs significantly. The system features a booster set fitted with motors with integrated frequency converters, allowing the booster system to maintain a constant pressure in the system and at the same time saves the space of large pressure holding tanks.

INTELLIGENT PUMPING

The job of a distribution pump is to transport hot water from main heat substations to the consumer installations, a task that demands intelligence as well as raw power. As heat consumption varies throughout the day, the ideal solution is a speed controlled pump that adapts to the fluctuating demand.

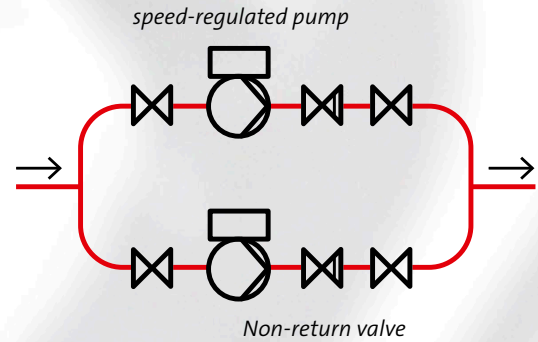
At Grundfos, we offer intelligent control with our CUE variable speed drive, which reduces the total cost of ownership drastically.

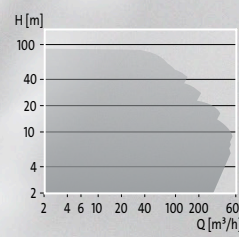

PUMP TYPE	OPERATING RANGE	FEATURES AND BENEFITS
 <p>NK/NKG end-suction pumps</p>		<ul style="list-style-type: none"> » Easy to service » Easy replaceable – dimensions according to EN and ISO standards » Bearing lifetime up to 100,000 hours
 <p>TP in-line pump</p>		<ul style="list-style-type: none"> » In-line pump installation » Small footprint » Simple installation (plug and pump)



Grundfos TP in-line pump Series 300

Sturdy, reliable and efficient, the TP range of Grundfos pumps is built to meet even the most demanding district energy conditions. The impeller is hydraulically and mechanically balanced to increase the life of the motor bearings and shaft seal. The inside of the pump is coated with Powercron® cathodic electro-coating and zinc phosphate which, together with the highly efficient IE3 Grundfos Blueflux® motor, keeps efficiency high throughout the lifetime of the pump.



THE RIGHT CONNECTION

Consumer connections are the final stop for heat energy in the district heating system. Consumers are the ones who ultimately benefit from the comfort and reliability of the right system.

Grundfos has a full range of solutions for all types of consumer connections: direct connections, indirect connections behind a plate heat exchanger, and connections in the form of a mixing loop. For direct connections, the substation regulates the pressure, but when it comes to indirect connections and mixing loops, system

performance and consumer comfort depend fully on the circulator.

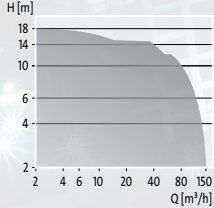
Grundfos solutions offer a new and intelligent approach to district heating. Get complete control of your system and give consumers unparalleled comfort while resting assured that reliability is high and energy consumption lower than ever.

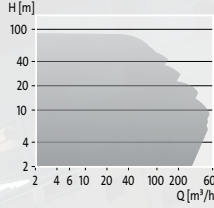
PUMP TYPE	OPERATING RANGE	FEATURES AND BENEFITS
 <p>MAGNA3 circulator pump</p>		<ul style="list-style-type: none"> » Low energy consumption » FLOWADAPT control mode (a combination of AUTOADAPT mode and a new FLOWLIMIT function) » Operating log » Energy monitor » Multi-pump function
 <p>TPE in-line pump Series 1000/2000</p>		<ul style="list-style-type: none"> » Designed for open or closed loop operation » Designed for coupling with any type of external sensor or pre-fitted with differential pressure sensor » Built-in frequency-controlled MGE motor



Monitoring and system integration

Grundfos supplies completely integrated solutions for building automation and building management systems, for optimised energy efficiency and enabling pre-emptive maintenance.

Solutions for stand-alone pumps

Grundfos E-pumps enable you to read data straight from pump HMI or through Grundfos GO remote control solution.

Solutions for building automation systems

Monitor and control your pumps and pump systems from anywhere in the world with Grundfos G501 connect box. Access your systems directly from your laptop, tablet or smartphone and see trend graphs, or stay updated on system performance.



Solutions for building management systems

A strong fieldbus solution is the cornerstone of any building management system. It guarantees flexible and cost-effective integration of pump data into management systems, and severely reduces the time spent on reporting and collecting data. Grundfos offers open and interoperable protocols for all our data bus networks.

CLEANING YOUR SYSTEM

A healthy district heating system demands clean make-up and circulating water. To avoid corrosion and precipitation in your installations, the water must be demineralised and deoxidised, free of mechanical impurities, and suitably alkalisised with few chemicals.

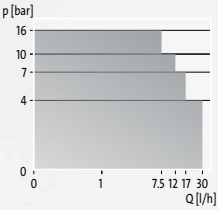
As a full-line supplier of intelligent water treatment solutions, we cover the entire water cycle and ensure that each step is provided with the perfect water quality. Our range covers all district heating needs – from softening and demineralisation to deoxidisation and alkalisisation.

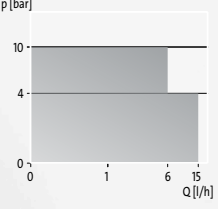
PUMP TYPE	Q AND H RANGE	DESCRIPTION
 <p>SMART Digital DDA</p>		<ul style="list-style-type: none"> » Internal stroke-speed and frequency control » Advanced control features » FlowControl with selective fault diagnosis » Integrated flow measurement and AUTO_{FLOWADAPT} » 0/4-20mA and 2 relay outputs » Auto deaeration » Power supply 100-240 V, 50/60 Hz
 <p>SMART Digital DDE</p>		<ul style="list-style-type: none"> » Internal stroke-speed and frequency control » Flexible range » Always full stroke length » Manual and pulse control » External stop and empty tank input » Power supply 100-240 V, 50/60 Hz



CONEX

- » Pre-assembled pH measuring and control system
- » Mounted on a base plate and wired ready for connection
- » Comes with prepared cable sets
- » Comes with temperature compensation



Grundfos SMART Digital DDA

The SMART Digital DDA dosing series offers impressive intelligence that goes beyond any existing pump technology on the market. The DDA is designed to inject chemicals and verify injection, measure valuable data such as flow or pressure, and diagnose the operation status. It will even make decisions to display and correct failures such as overpressure, valve leaks or air bubbles.

OPTIMISING THE DISTRIBUTION LINE

REDUCING HEAT LOSSES IN THE DISTRIBUTION LINE

The lower the temperature you can operate with, the more you will reduce your heat losses, and the more you can expand your network. Similarly, with a lower operating temperature, the more flow is needed to deliver the same energy.

Booster pumps to reduce heat loss through distributed pumping

By distributing pumps in the network, you can effectively minimise the residual pressure and reduce the heat losses.

Temperature zoning to reduce heat losses

By utilising mixing loops with control in the network, you can create consumer-dependent temperature zones; e.g., a new floor-heated domestic area requires far lower temperatures than an industrial area.



With a mixing loop and/or booster system in the pit, you get:

- Reduced heat losses
- Intelligent control
- Easy installation (plug-and-pump)

Grundfos pumps up to 22 kW are supplied with integrated control modes.

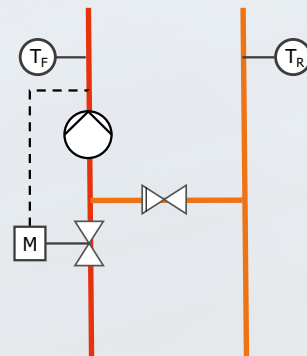
Temperature zoning with mixing loops

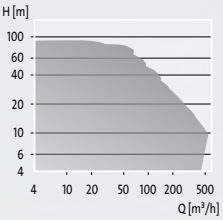

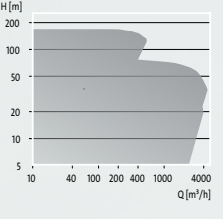
PUMP TYPE	OPERATING RANGE	FEATURES AND BENEFITS
 <p>TPE in-line pump</p>		<ul style="list-style-type: none"> » Low energy consumption » Intelligent control » Adaptation to existing operating conditions
 <p>TP in-line pump</p>		<ul style="list-style-type: none"> » Simple installation » Small footprint » High hydraulic efficiency

WANT TO SAVE UP TO 50%?

Save thousands of kWhs with energy checks, pump audits and energy-efficient pumping solutions

For district heating plants, minimal energy consumption is high on the agenda and a 30-50% reduction of pump energy usage means thousands of kWhs saved, as well as a drastic CO₂ reduction. Grundfos has made savings like these very achievable with our energy checks, pump audits and energy-efficient pumping solutions.

Measure, analyse, advise

A pump audit is performed by Grundfos specialists based on a number of measurements. It focuses on the amount of hot water the pumps are handling and the flow variations during a relatively short and well-defined period. The Grundfos specialist measures and records the following in the system:

- » Countable values e.g. flow and energy consumption
- » Analogue values e.g. pressure, temperature, water levels
- » Incident rates e.g. pump start/stop, valve open/close

The audit assesses the overall efficiency of a system's pumps and proposes the needed changes that will improve efficiency. The proposals are supported by calculations of the savings to be made, the reduction in CO₂ emissions, and the payback time on any investment.

Expect savings

Our energy audits are known to result in considerable savings on running costs as well as significant reductions to installation carbon footprint. Contact your Grundfos sales company to learn more.

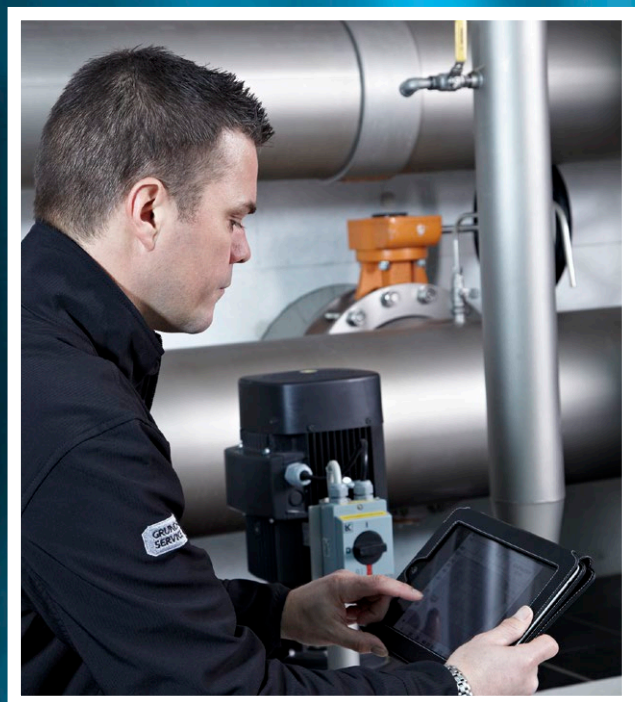



Global presence: Wherever a district heating pumping solution is needed, there is a Grundfos company nearby, ready to assist you

RELY ON 50 YEARS OF EXPERIENCE AND CUTTING EDGE TECHNOLOGY

Grundfos is one of the world's leading pump manufacturers and has been renowned for its innovative and reliable solutions since the humble beginnings in 1945.

Today, we produce more than 16 million pump units every year for a wide range of application areas – from circulators for heating and air conditioning to industrial pumps and solutions for water supply, wastewater and District Heating.

Our vast experience with District Heating dates back 50 years. Scandinavian district heating is the most efficient and reliable heating system in the world, and Grundfos technology is a proud part of that legacy.

Worldwide production

Grundfos is represented by 80 companies in more than 55 countries and owns production facilities all over the world. This makes our products and services easily accessible to customers globally.

We cover the whole system

In addition to pumps, Grundfos produces standard and submersible motors as well as state-of-the-art electronics for monitoring and controlling pumps.





Grundfos is one of the world's leading suppliers of solutions across the full range of pump applications – all the way from water supply to wastewater treatment.

In Grundfos District Heating, we think beyond the pump. We look at the entire system – from power plant to end user – to provide you with the most intelligent, reliable and adaptable solutions possible.

This approach has made us a preferred partner for district heating companies across the globe, and we look forward to helping you as well.

To learn more go to
www.grundfos.com/districtenergy